



SPECIALTY

**CH
A
H
N**

SPECIALTY CHAIN

HOLLOW-PIN CHAIN



1. All KSP hollow-pin chains are **manufactured** with **precision**.
2. KSP hollow-pin chain provides a **multitude** of possibilities for **attachments** and **cross-rod spacing**.
3. Ideal for **easy assembly** and disassembly of attachments.

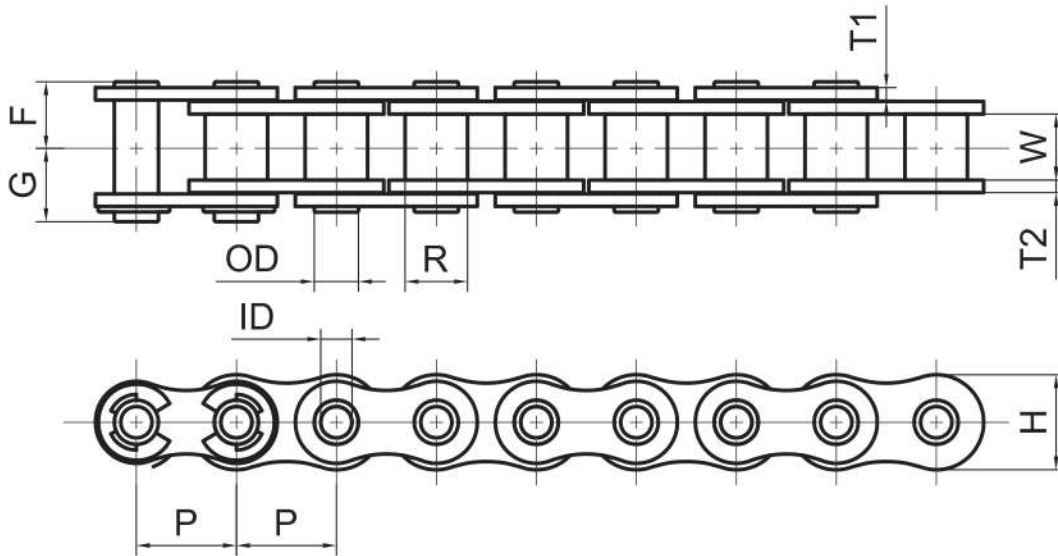

Chain	Pitch	Bushing		Hollow Pin		Plate			Overall Width		Avg. Ult. Tensile Strength (Lbs.)	Max. Working Load (Lbs.)	Avg. Weight Per Foot
		Width	Dia.	Inside Dia.	Outside Dia.	Height	Thickness						
		P	W	R	ID	OD	H	T1	T2	F			
40HP	0.500	0.312	0.312	0.157	0.225	0.475	0.060	0.060	0.330	0.357	2,977	440	0.36
50HP	0.625	0.375	0.400	0.202	0.287	0.594	0.080	0.080	0.408	0.459	4,741	700	0.58
60HP	0.750	0.500	0.469	0.235	0.331	0.712	0.094	0.094	0.513	0.553	6,064	900	0.86
80HP	1.000	0.625	0.625	0.313	0.450	0.950	0.125	0.125	0.662	0.699	11,576	1710	1.48
08BHP	0.500	0.305	0.335	0.177	0.242	0.465	0.059	0.067	0.324	0.368	2,867	425	0.44
10BHP	0.625	0.380	0.400	0.202	0.287	0.580	0.067	0.067	0.383	0.430	4,079	600	0.54
12BHP	0.750	0.460	0.475	0.197	0.276	0.635	0.073	0.073	0.441	0.522	4,741	710	0.77

SPECIALTY CHAIN

HOLLOW-PIN DOUBLE PITCH CHAIN



1. All KSP hollow-pin chains are **manufactured** with **precision**.
2. KSP hollow-pin chain provides a **multitude** of possibilities for **attachments** and **cross-rod spacing**.
3. Ideal for **easy assembly** and disassembly of attachments.

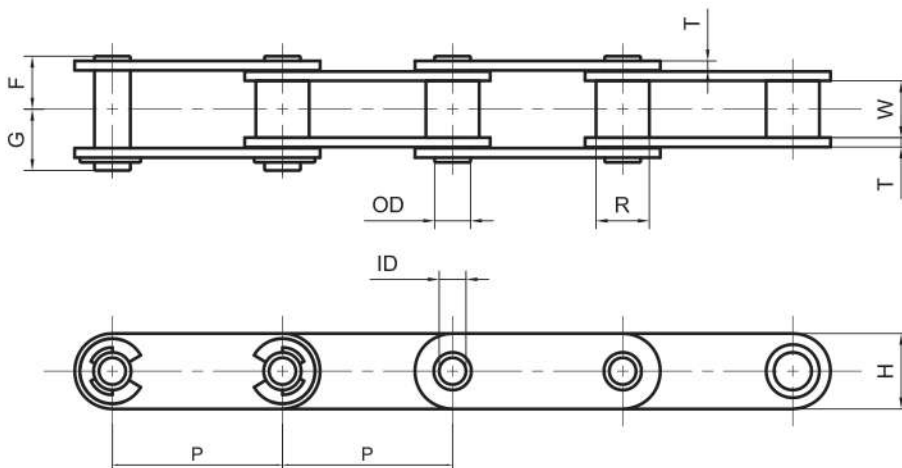

Chain	Pitch P	Bushing		Roller	Hollow Pin		Plate		Overall Width		Avg. Ult. Tensile Strength (Lbs.)	Max Working Load (Lbs.)	Avg. Weight Per Foot
		Width W	Dia. R1	Dia. R2	Inside Dia. ID	Outside Dia. OD	Height H	Thickness T	F	G			
C2040HP	1.000	0.312	0.312	-	0.157	0.225	0.463	0.060	0.330	0.357	2,976	440	0.316
C2042HP	1.000	0.312	-	0.625	0.157	0.225	0.463	0.060	0.330	0.357	2,976	440	0.558
C2050HP	1.250	0.375	0.400	-	0.202	0.287	0.594	0.080	0.408	0.459	4,740	700	0.538
C2052HP	1.250	0.375	-	0.750	0.202	0.287	0.594	0.080	0.408	0.459	4,740	700	0.853
C2060HP	1.500	0.500	0.469	-	0.235	0.331	0.712	0.094	0.513	0.553	6,063	900	0.759
C2062HP	1.500	0.500	-	0.875	0.235	0.331	0.712	0.094	0.513	0.553	6,063	900	0.947
C2080HP	2.000	0.625	0.625	-	0.313	0.450	0.950	0.125	0.662	0.699	11,574	1,700	1.144
C2082HP	2.000	0.625	-	1.125	0.313	0.450	0.950	0.125	0.662	0.699	11,574	1,700	1.854
C2060H HP	1.500	0.500	0.469	-	0.235	0.331	0.712	0.125	0.567	0.606	5,842	850	0.947
C2062H HP	1.500	0.500	-	0.875	0.235	0.331	0.712	0.125	0.567	0.606	5,842	850	1.431
C2080H HP	2.000	0.625	0.625	-	0.313	0.450	0.950	0.156	0.744	0.709	11,354	1,700	1.599
C2082H HP	2.000	0.625	-	1.125	0.313	0.450	0.950	0.156	0.744	0.709	11,354	1,700	2.318
C2120H HP	3.000	1.000	0.875	-	0.441	0.631	1.369	0.217	1.081	1.120	25,419	3,800	3.481
C2122H HP	3.000	1.000	-	1.750	0.441	0.639	1.369	0.217	1.081	1.120	25,420	3,800	5.436

SPECIALTY CHAIN

SIDE BOW CHAIN



1. All KSP sidebow chains incorporate **tapered bushings**.
2. **Increased clearance** between pins, bushings, and sideplates allow for extra side bow.
3. Provides **greater flexibility** on curved tracks.

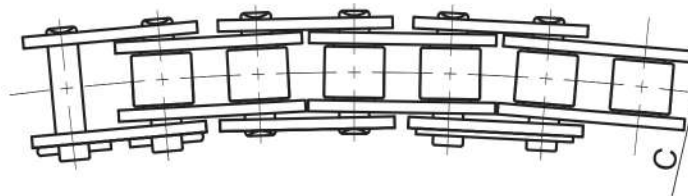
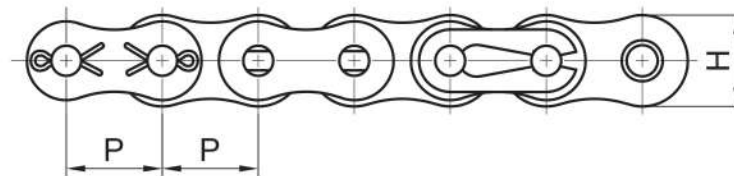
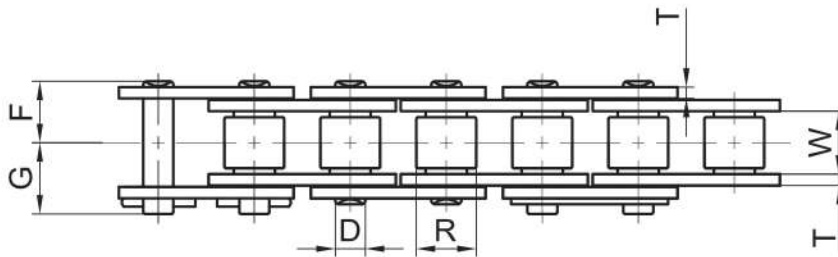

Chain	Pitch P	Roller		Plate		Pin Dia. D	Overall Width		Min Radius of Curve C	Avg. Ult. Tensile Strength (Lbs.)	Max. Working Load (Lbs.)	Avg. Weight Per Foot (Lbs.)
		Width W	Dia. R	Height H	Thickness T		F	G				
		35 SB	0.375	0.188	0.200		0.356	0.050				
40 SB	0.500	0.312	0.312	0.475	0.060	0.157	0.336	0.419	14.000	3,520	420	0.417
50 SB	0.625	0.375	0.400	0.594	0.080	0.200	0.415	0.526	16.000	5,500	650	0.679
60 SB	0.750	0.500	0.469	0.712	0.094	0.235	0.526	0.627	20.000	7,700	910	0.974
80 SB	1.000	0.625	0.625	0.950	0.125	0.313	0.701	0.835	24.000	14,500	1,700	1.714

SPECIALTY CHAIN

SIDE BOW DOUBLE PITCH CHAIN



1. All KSP sidebow chains incorporate **tapered bushings**.
2. **Increased clearance** between pins, bushings, and sideplates allow for extra side bow.
3. Provides **greater flexibility** on curved tracks.

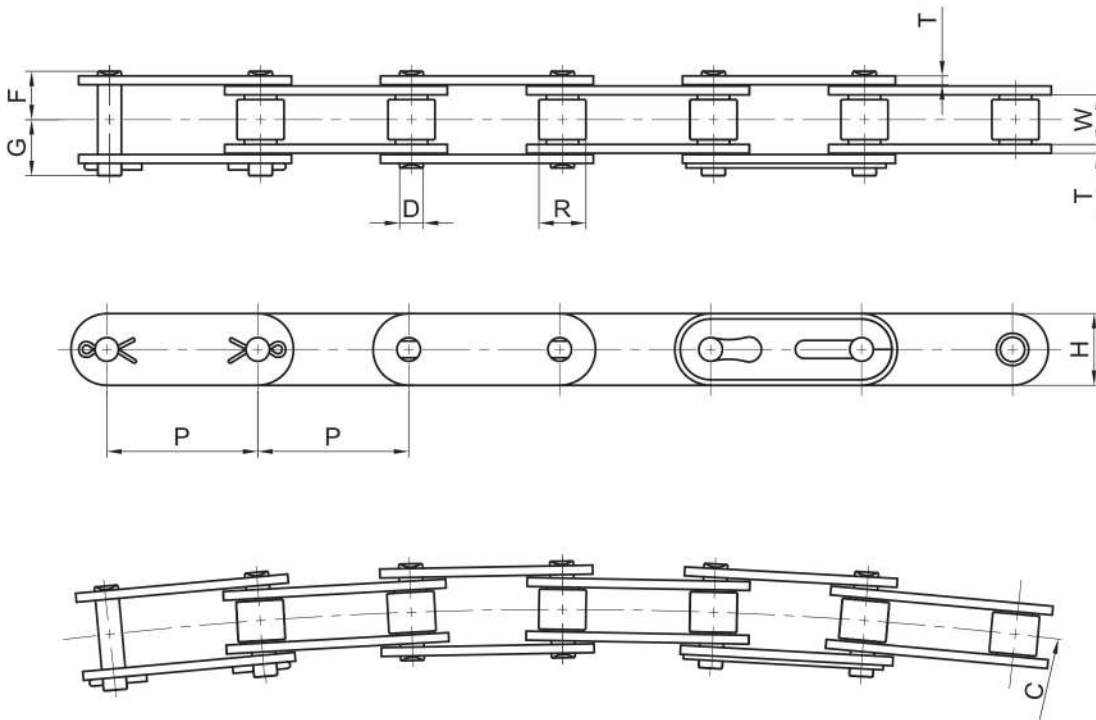

Chain	Pitch P	Roller		Plate		Pin Dia. D	Overall Width		Min Radius of Curve C	Avg. Ult. Tensile Strength (Lbs.)	Max. Working Load (Lbs.)	Avg. Weight Per Foot (Lbs.)
		Width W	Dia. R	Height H	Thickness T		F	G				
C2040 SB	1.000	0.312	0.312	0.463	0.060	0.157	0.335	0.419	27.000	3,520	420	0.318
C2050 SB	1.250	0.375	0.400	0.594	0.080	0.200	0.415	0.526	31.496	5,500	650	0.541
C2060 SB	1.500	0.500	0.469	0.712	0.094	0.235	0.526	0.627	39.000	7,700	910	0.763
C2080 SB	2.000	0.625	0.625	0.950	0.125	0.313	0.681	0.835	47.000	14,520	1,700	1.400

SPECIALTY CHAIN

SIDE BOW SNAP-ON TOP CHAIN



1. KSP Snap-On chains are available in **standard** or **side bow** configurations.
2. The **rivetless pins are extended** to accommodate attachments and easily “snap” on or off.
3. Chains are available in Carbon Steel, Nickel-Plated, and Stainless Steel.

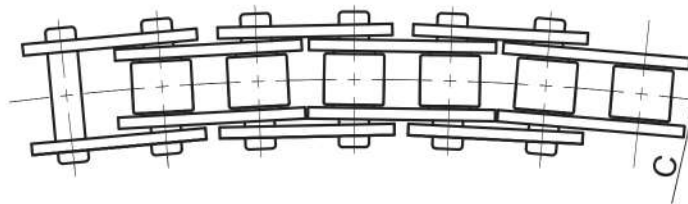
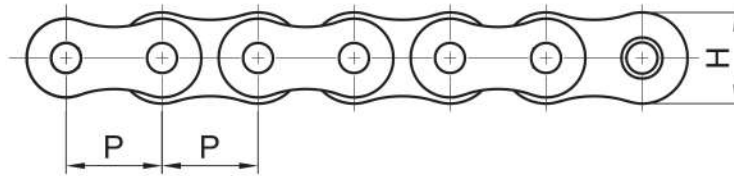
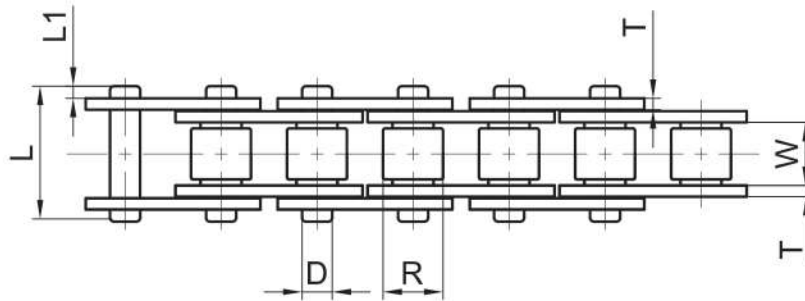

Chain	Pitch P	Roller		Plate		Pin Dia. D	Overall Width		Min Radius of Curve C	Avg. Ult. Tensile Strength (Lbs.)	Max. Working Load (Lbs.)	Avg. Weight Per Foot (Lbs.)
		Width W	Dia. R	Height H	Thickness T		L	G				
43 SB	0.500	0.312	0.312	0.463	0.060	0.136	0.724	0.070	12.000	2,750	330	0.430
43NP SB	0.500	0.312	0.312	0.463	0.060	0.136	0.724	0.070	12.000	2,750	330	0.430
43SS SB	0.500	0.312	0.312	0.463	0.060	0.136	0.724	0.070	12.000	1,650	190	0.430
43PHSS SB	0.500	0.312	0.312	0.463	0.060	0.136	0.724	0.070	12.000	2,200	260	0.430
63 SB	0.750	0.500	0.469	0.685	0.094	0.200	1.140	0.120	14.000	6,050	720	1.010
63NP SB	0.750	0.500	0.469	0.685	0.094	0.200	1.140	0.120	14.000	6,050	720	1.010
63SS SB	0.750	0.500	0.469	0.685	0.094	0.200	1.140	0.120	14.000	3,630	460	1.010
63PHSS SB	0.750	0.500	0.469	0.685	0.094	0.200	1.140	0.120	14.000	4,840	580	1.010

SPECIALTY CHAIN

O-RING CHAIN



1. Synthetic rubber O-Rings **seal in lubricant** within the bearing area of the chain.
2. Ideal for applications where keeping dirt and other **contaminants out** of the bearing area are critical.
3. Commonly used where continuous re-lubrication can be difficult.
4. All O-Ring chain has quad-staked pins to allow **greater pin push-out** force.

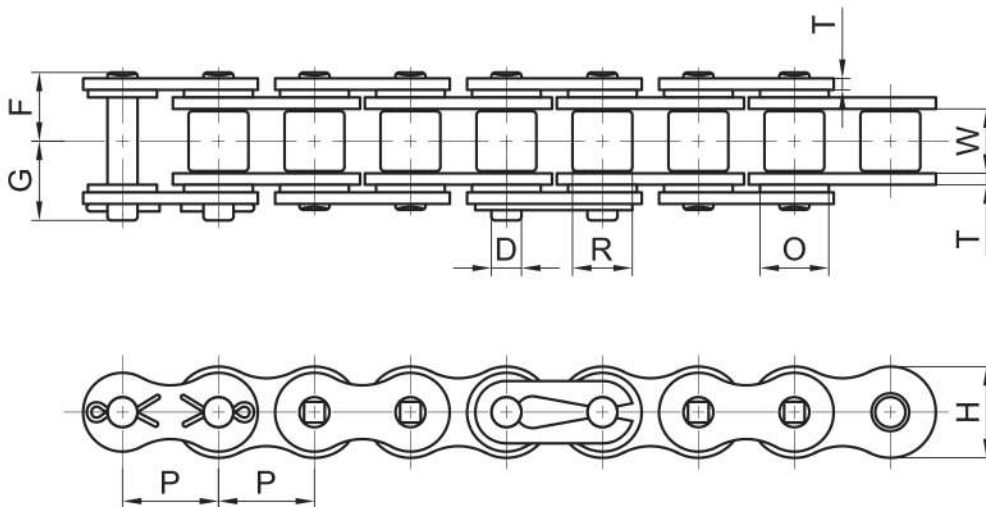

Chain	Pitch P	Roller		Plate		Pin Dia. D	Overall Width		Avg. Ult. Tensile Strength (Lbs.)	Max. Working Load (Lbs.)	Avg. Weight Per Foot (Lbs.)
		Width	Dia.	Height	Thickness		F	G			
		W	R	H	T						
40 O-Ring	0.500	0.312	0.312	0.475	0.060	0.157	0.357	0.412	4,180	500	0.420
50 O-Ring	0.625	0.375	0.400	0.594	0.080	0.200	0.458	0.475	6,900	800	0.700
60 O-Ring	0.750	0.500	0.469	0.712	0.094	0.235	0.546	0.585	10,300	1,225	1.000
80 O-Ring	1.000	0.625	0.625	0.950	0.125	0.313	0.690	0.766	17,900	2,150	1.900
100 O-Ring	1.250	0.750	0.750	1.187	0.156	0.376	0.843	1.035	27,500	3,300	2.350
120 O-Ring	1.500	1.000	0.875	1.425	0.187	0.437	1.114	1.240	36,000	4,250	4.400

SPECIALTY CHAIN

TOP ROLLER CHAIN

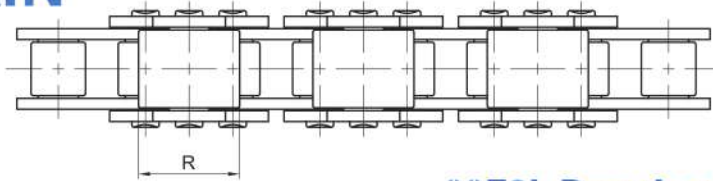

****E2L Drawing Shown**

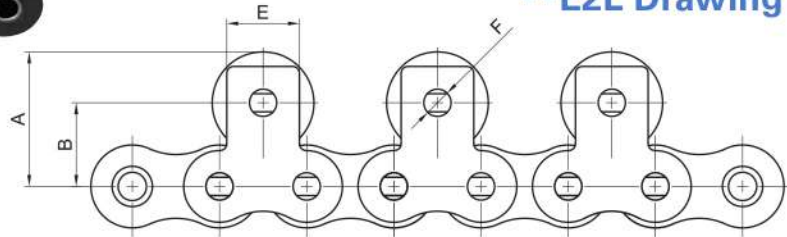

Chain	Pitch	Top Roller				Top Roller Diameter		*EL Avg. Weight Per Foot (Lbs.)	*E2L Avg. Weight Per Foot (Lbs.)
		Height	Center	Face	Pin Dia	*EL	**E2L		
	P	A	B	E	F	R	R		
60	0.625	1.031	0.719	0.625	0.235	0.709	0.875	2.45	2.27
80	1.000	1.341	0.969	0.750	0.313	0.945	1.125	4.10	3.97
100	1.250	1.752	1.252	1.000	0.376	1.181	1.562	6.25	5.81

*EL Top Roller Every Link

**E2L Top Roller Every Second Link

1. Top Roller Chains are typically used in **transfer systems**.
2. Top Rollers are available with **steel or plastic materials**.

TOP ROLLER DOUBLE PITCH CHAIN

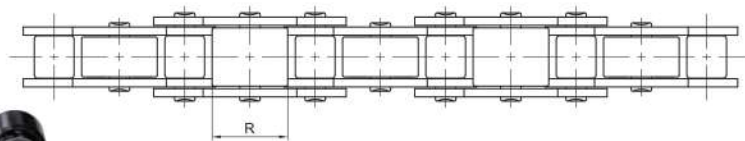

***EL Drawing Shown**

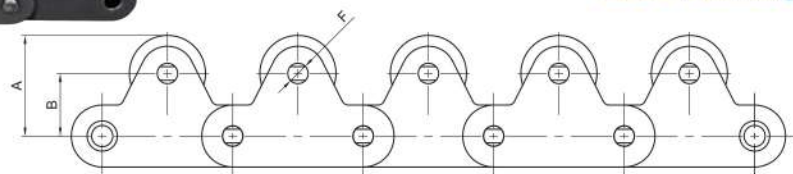

Chain	Pitch	Top Roller			Top Roller Diameter	Avg. Weight Per Foot (Lbs.)
		Height	Center	Pin Dia.		
	P	A	B	F	R	
C2060H	1.500	1.004	0.689	0.235	0.875	2.15
C2062H	1.500	1.316	1.001	0.235	0.875	3.00
C2080H	2.000	1.594	1.142	0.437	1.125	3.80
C2082H	2.000	1.594	1.142	0.437	1.125	4.55
C2100H	2.500	1.957	1.394	0.563	1.562	6.15
C2102H	2.500	1.957	1.394	0.563	1.562	7.70

SPECIALTY CHAIN

DOUBLE CAPACITY CHAIN

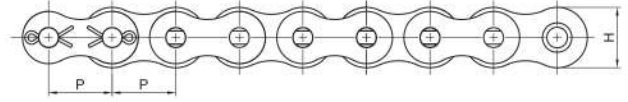
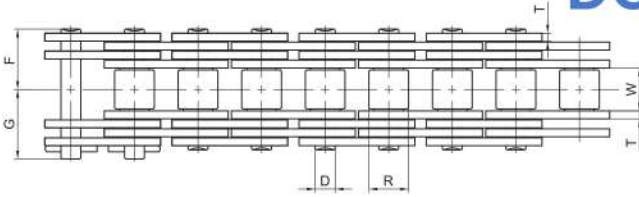

Chain	Pitch P	Roller		Plate		Pin Dia. D	Overall Width		Avg. Ult. Tensile Strength (Lbs.)	Max. Working Load (Lbs.)	Avg. Weight Per Foot (Lbs.)
		Width	Dia.	Height	Thickness		F	G			
		W	R	H	T						
60 DC	0.750	0.500	0.469	0.712	0.094	0.235	0.695	0.795	18,920	2,250	1.62
80 DC	1.000	0.625	0.625	0.950	0.125	0.313	0.898	0.959	35,970	4,250	3.02
100 DC	1.250	0.750	0.750	1.187	0.156	0.376	1.098	1.171	58,630	7,000	4.66
120 DC	1.500	1.000	0.875	1.425	0.187	0.437	1.358	1.443	77,550	9,200	6.63
140 DC	1.750	1.000	1.000	1.662	0.219	0.500	1.504	1.596	101,200	12,100	8.70
160DC	2.000	1.250	1.125	1.900	0.250	0.563	1.772	1.872	128,700	14,150	11.44
180 DC	2.250	1.406	1.406	2.137	0.281	0.687	2.000	2.120	171,600	18,850	14.84
200 DC	2.500	1.500	1.562	2.375	0.312	0.781	2.189	2.362	247,500	27,225	18.33
240 DC	3.000	1.875	1.875	2.850	0.375	0.937	2.669	2.819	312,400	34,330	28.26



1. KSP Double Capacity Roller Chain incorporates **twice the link plates** per chain to double the chain's rated capacity.
2. Employs KSP Quest™ chain technology: Solid, one-piece cold formed bushings which **improves wear resistance** and provides **superior defiance to elongation**.
3. Commonly used in tension linkage applications, such as **high load hoists** and **severe duty drives** operating at slow to medium speed.

DOUBLE CAPACITY DOUBLE PITCH CHAIN

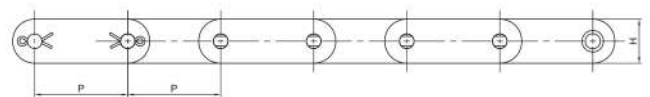
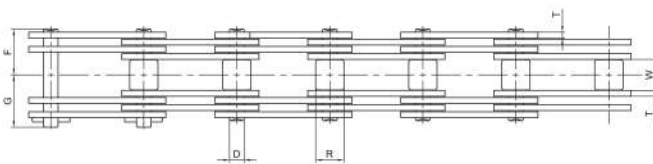

Chain	Pitch P	Roller		Plate		Pin Dia. D	Overall Width		Avg. Ult. Tensile Strength (Lbs.)	Max. Working Load (Lbs.)	Avg. Weight Per Foot (Lbs.)
		Width	Dia.	Height	Thickness		F	G			
		W	R	H	T						
C2060H DC	1.500	1.000	0.469	0.712	0.125	0.235	0.829	0.925	24,200		1.71

SPECIALTY CHAIN

BINDERY CHAIN 12B

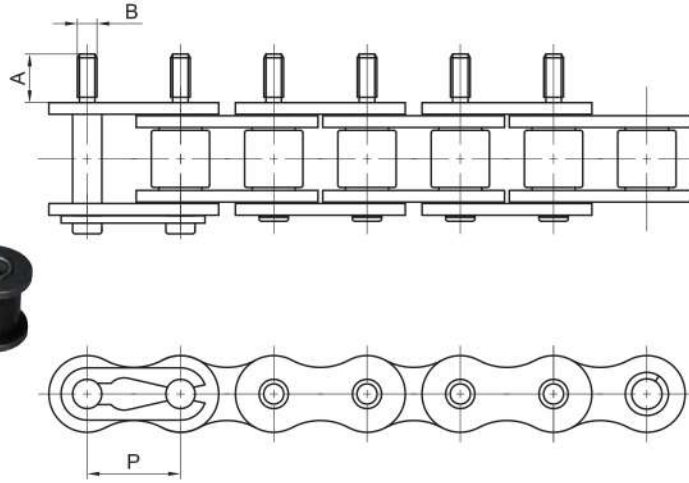

Chain	Pitch	Bindery Attachment		Avg. Weight Per Foot (Lbs.)
	P	A	B	
12B Bindery	0.750	0.390	M4 x 0.7P	0.90

1. Commonly used in book binding applications.

BINDERY CHAIN 40R

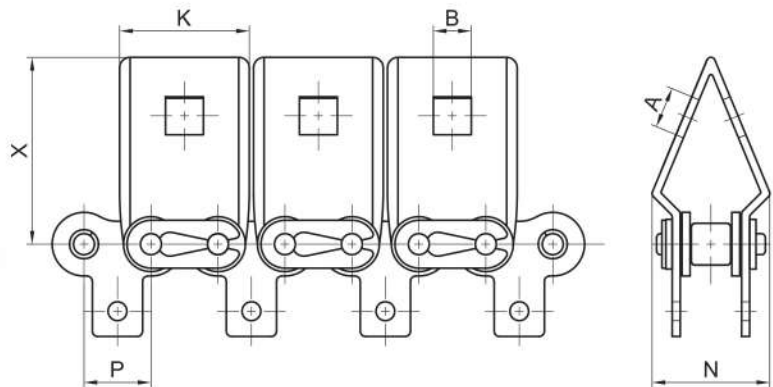

Chain	Pitch	Bindery Attachment					Avg. Weight Per Foot (Lbs.)
	P	K	X	N	A	B	
40 Bindery	0.500	0.970	1.390	0.838	0.283	0.283	1.20

SPECIALTY CHAIN

WRENCH CHAIN



1. KSP wrench chain is commonly used to hold or turn smooth, circular objects such as pipe or car parts.

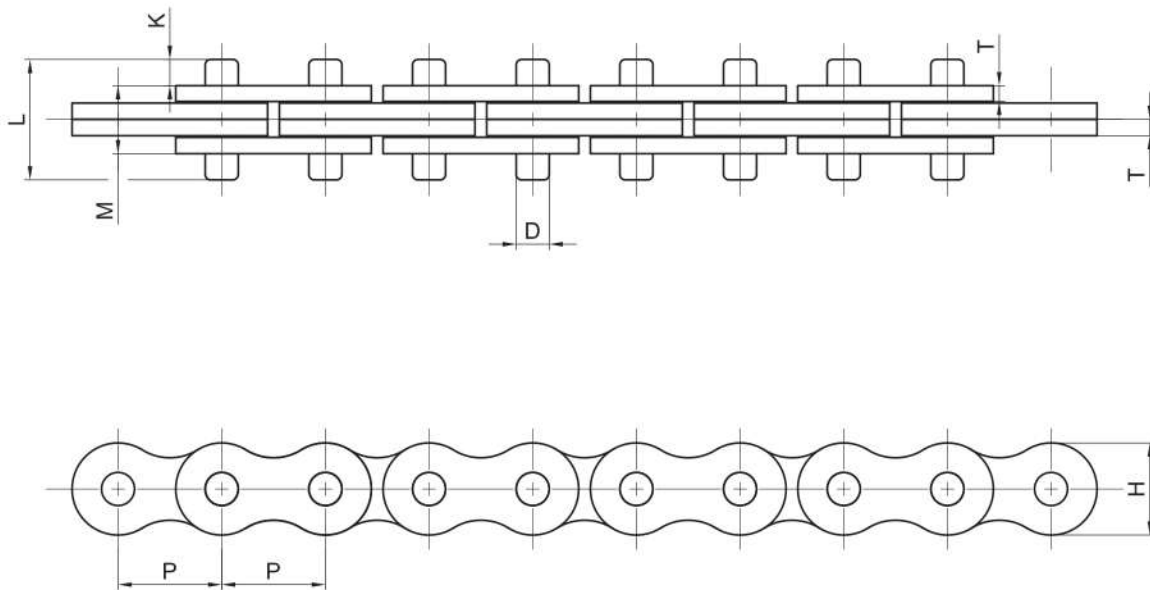

Chain	Pitch	Lacing	Plate		Pin Dia.	Overall Width			Avg. Ult. Tensile Strength (Lbs.)	Avg. Weight Per Foot (Lbs.)
			Height	Thickness		L	K	M		
	P		H	T	D					
5/8WR	0.625	2 X 2	0.500	0.077	0.200	0.688	0.172	0.344	6,600	0.410
3/4WR	0.750	2 X 2	0.667	0.118	0.240	0.875	0.178	0.520	12,000	0.950

SPECIALTY CHAIN

POLY STAINLESS STEEL CHAIN



1. All KSP Chain Poly Chain incorporates **plastic roller** links with **304 stainless steel pin link plates**.
2. The combination of stainless steel and plastic **prevent the need for lubrication**.
3. Poly Chain is commonly used in both **drive and conveyance applications**.

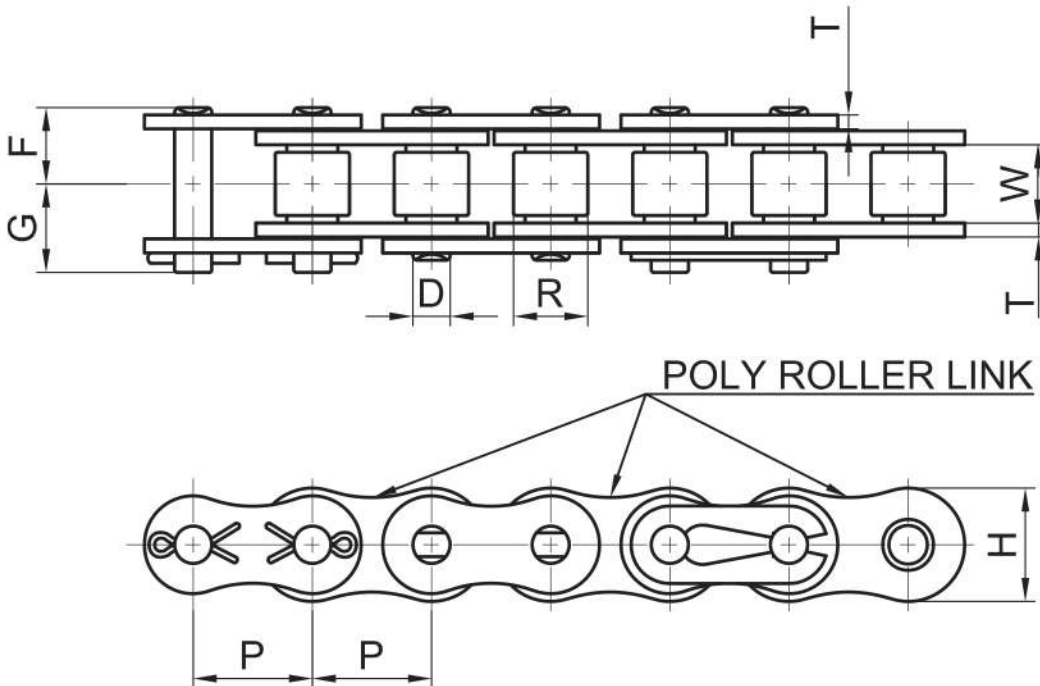

Chain	Pitch P	Roller		Plate		Pin Dia. D	Overall Width		Max. Working Load (Lbs.)	Avg. Weight Per Foot (Lbs.)
		Width W	Dia. R	Height H	Thickness T		F	G		
		40 Poly	0.500	0.309	0.312		0.465	0.060		
50 Poly	0.625	0.370	0.400	0.579	0.080	0.200	0.407	0.470	150	0.550
60 Poly	0.750	0.495	0.469	0.701	0.094	0.234	0.504	0.581	200	0.700

SPECIALTY CHAIN

NON-STANDARD ROLLER CHAIN



1. Non-Standard roller chains are ANSI/ASME base chains with modified dimensions to **meet demanding applications**.
2. All chain components are **heat-treated** to achieve maximum strength and greater wear resistance.
3. All KSP roller chain is **pre-loaded** during the manufacturing process to minimize initial elongation.
4. **Hot-dipped lubrication** ensures 100% lubrication of all chain components to extend wear life and reduce maintenance costs.

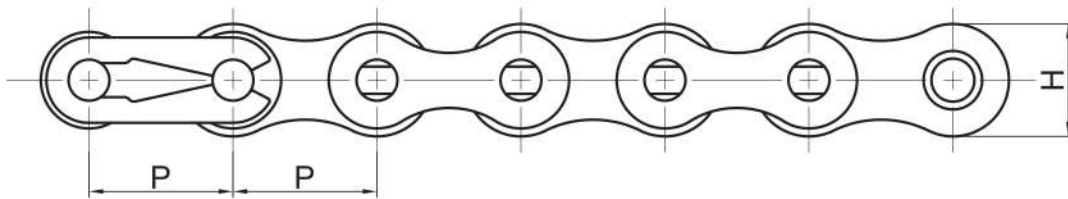
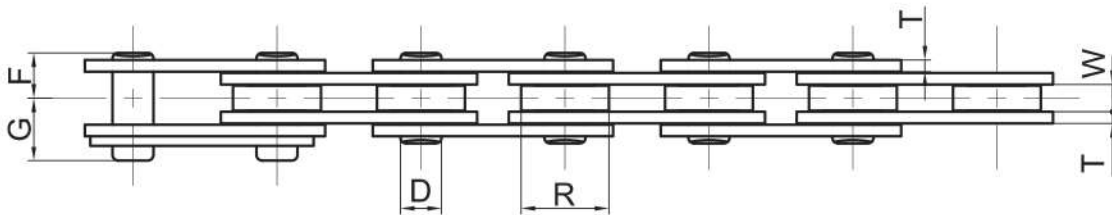

Chain	Pitch P	Roller		Plate		Pin Dia. D	Overall Width		Avg. Ult. Tensile Strength (Lbs.)	Avg. Weight Per Foot (Lbs.)
		Width W	Dia. R	Height H	Thickness T		F	G		
410	0.500	0.125	0.306	0.390	0.039	0.142	0.184	0.233	1,900	0.190
408	0.500	0.094	0.306	0.390	0.039	0.142	0.149	0.190	1,900	0.180
415	0.500	0.188	0.306	0.390	0.039	0.142	0.216	0.262	2,100	0.240
415H	0.500	0.188	0.306	0.469	0.060	0.156	0.263	0.301	3,700	0.330
420	0.500	0.250	0.306	0.469	0.060	0.156	0.288	0.344	3,700	0.380
423	0.500	0.250	0.335	0.469	0.060	0.176	0.288	0.338	4,600	0.420
428	0.500	0.312	0.335	0.469	0.060	0.176	0.324	0.371	4,600	0.440
428H	0.500	0.313	0.335	0.476	0.071	0.176	0.350	0.392	5,300	0.550
520	0.625	0.250	0.400	0.585	0.079	0.200	0.344	0.394	6,100	0.640
525	0.625	0.312	0.400	0.585	0.079	0.200	0.376	0.425	6,100	0.680

SPECIALTY CHAIN

ROLLERLESS CHAIN



1. Rollerless chains are assembled **without the roller** and have the same dimensional and tensile strengths as standard ANSI/ASME chains.
2. All chain components are **heat-treated** to achieve maximum strength and greater wear resistance.
3. All KSP roller chain is **pre-loaded** during the manufacturing process to minimize initial elongation.
4. **Hot-dipped lubrication** ensures 100% lubrication of all chain components to extend wear life and reduce maintenance costs.

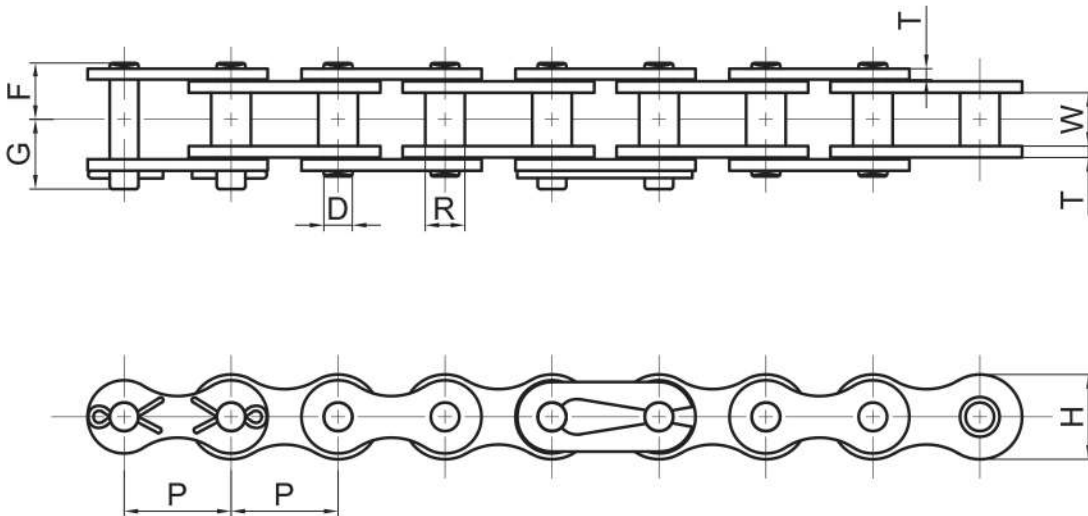

Chain	Pitch P	Bushing		Plate		Pin Dia. D	Overall Width		Avg. Ult. Tensile Strength (Lbs.)	Avg. Weight Per Foot (Lbs.)
		Width	Dia.	Height	Thickness		F	G		
		W	R	H	T					
55	0.625	0.375	0.278	0.594	0.080	0.200	0.400	0.488	6,834	0.600
65	0.750	0.500	0.330	0.712	0.094	0.235	0.501	0.601	9,259	0.836
85	1.000	0.625	0.443	0.950	0.125	0.313	0.650	0.803	17,636	1.486
105	1.250	0.750	0.535	1.187	0.156	0.376	0.781	0.950	25,353	2.386
125	1.500	1.000	0.627	1.425	0.187	0.437	1.005	1.174	34,392	3.103

SPECIALTY CHAIN

BLOCK CHAIN



B Style Shown

- Block chain is available in three configurations:
 - B:** solid blocks made of powdered metal
 - BL:** laminated blocks made of steel plates
 - BLSS:** laminated blocks made of stainless steel
- Block Chains are used in **low speed** and **light-weight conveyance** applications.

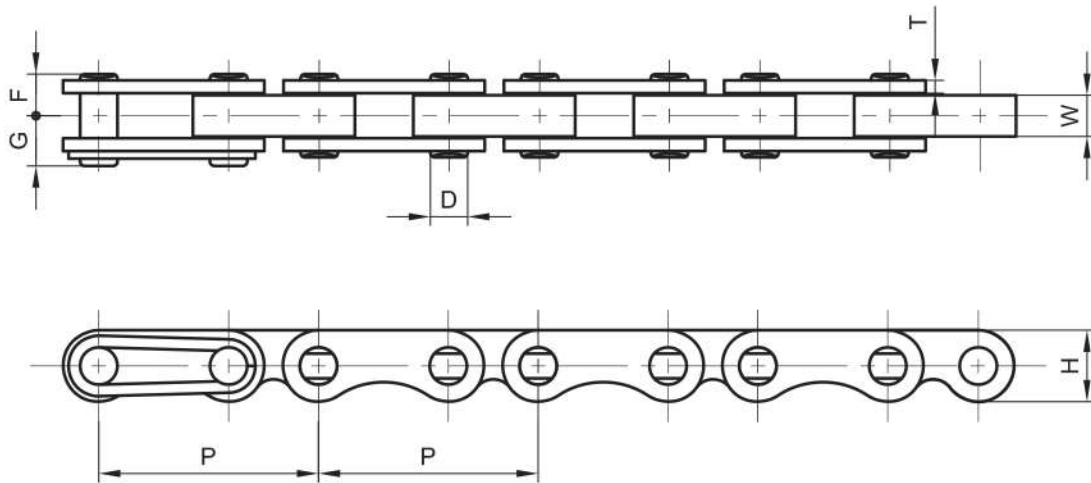

Chain	Pitch P	Block	Plate		Pin Dia. D	Overall Width		Avg. Ult. Tensile Strength (Lbs.)	Avg. Weight Per Foot (Lbs.)
		Width	Height	Thickness		F	G		
		W	H	T					
502B	1.000	0.187	0.325	0.059	0.170	0.189	0.228	1,300	0.230
503B	1.000	0.250	0.325	0.059	0.170	0.222	0.262	1,500	0.264
504B	1.000	0.313	0.325	0.079	0.187	0.279	0.320	1,500	0.329
505B	1.000	0.375	0.325	0.079	0.187	0.311	0.350	1,975	0.371
506B	1.000	0.500	0.325	0.079	0.187	0.373	0.412	1,975	0.444

SPECIALTY CHAIN

ROLLERLESS CHAIN



1. Rollerless chains are assembled **without the roller** and have the same dimensional and tensile strengths as standard ANSI/ASME chains.
2. All chain components are **heat-treated** to achieve maximum strength and greater wear resistance.
3. All KSP roller chain is **pre-loaded** during the manufacturing process to minimize initial elongation.
4. **Hot-dipped lubrication** ensures 100% lubrication of all chain components to extend wear life and reduce maintenance costs.

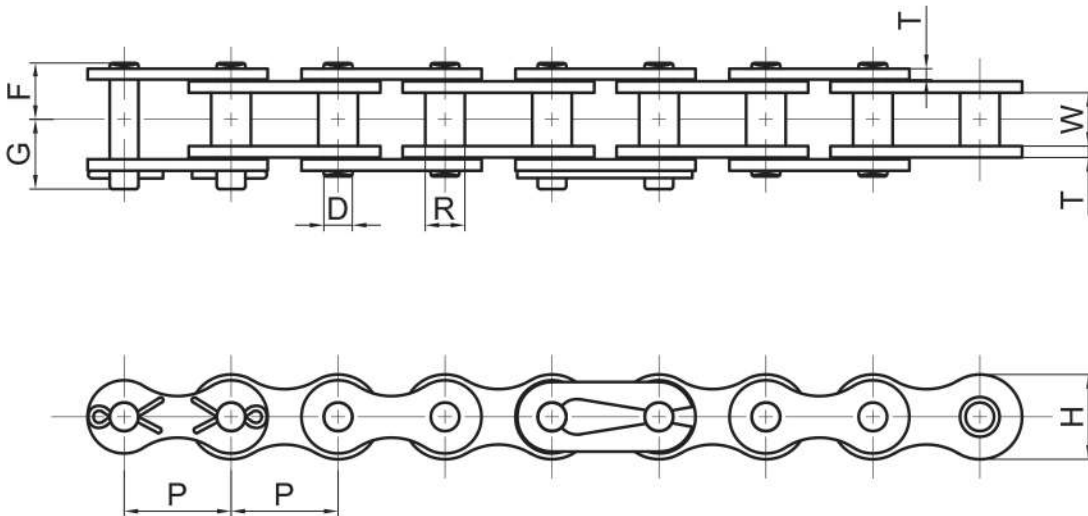

Chain	Pitch P	Bushing		Plate		Pin Dia. D	Overall Width		Avg. Ult. Tensile Strength (Lbs.)	Avg. Weight Per Foot (Lbs.)
		Width	Dia.	Height	Thickness		F	G		
		W	R	H	T					
55	0.625	0.375	0.278	0.594	0.080	0.200	0.400	0.488	6,834	0.600
65	0.750	0.500	0.330	0.712	0.094	0.235	0.501	0.601	9,259	0.836
85	1.000	0.625	0.443	0.950	0.125	0.313	0.650	0.803	17,636	1.486
105	1.250	0.750	0.535	1.187	0.156	0.376	0.781	0.950	25,353	2.386
125	1.500	1.000	0.627	1.425	0.187	0.437	1.005	1.174	34,392	3.103

SPECIALTY CHAIN

SNAP-ON TOP CHAIN



1. KSP Snap-On chains are available in **standard** or **side bow** configurations.
2. The **rivetless pins are extended** to accommodate attachments and easily “snap” on or off.
3. Chains are available in Carbon Steel, Nickel-Plated, and Stainless Steel.

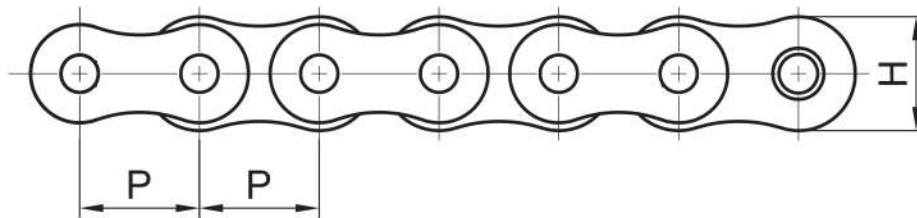
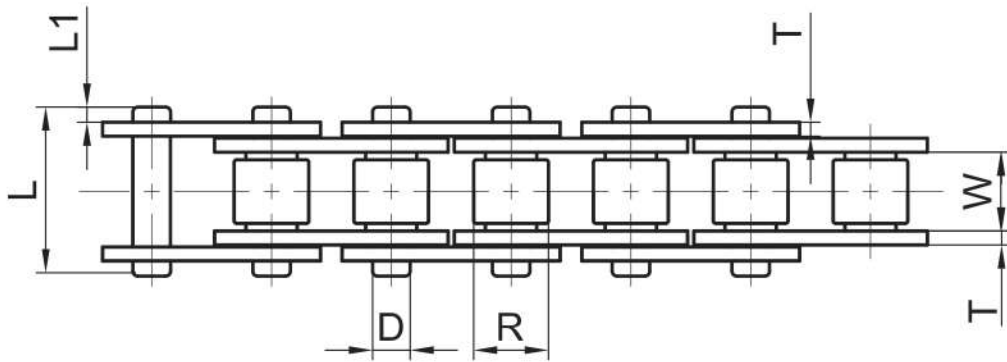

Chain	Pitch P	Roller		Plate		Pin Dia. D	Overall Width		Avg. Ult. Tensile Strength (Lbs.)	Max. Working Load (Lbs.)	Avg. Weight Per Foot (Lbs.)
		Width	Dia.	Height	Thickness		L	G			
		W	R	H	T						
43	0.500	0.312	0.312	0.463	0.060	0.157	0.704	0.065	4,070	810	0.460
43NP	0.500	0.312	0.312	0.463	0.060	0.157	0.704	0.065	4,070	810	0.460
43SS	0.500	0.312	0.312	0.463	0.060	0.157	0.704	0.065	2,200	440	0.460
43PHSS	0.500	0.312	0.312	0.463	0.060	0.157	0.704	0.065	2,860	570	0.460
63	0.750	0.500	0.469	0.685	0.094	0.235	1.110	0.104	9,130	1,800	1.090
63NP	0.750	0.500	0.469	0.685	0.094	0.235	1.110	0.104	9,130	1,800	1.090
63SS	0.750	0.500	0.469	0.685	0.094	0.235	1.110	0.104	5,500	1,100	1.090
63PHSS	0.750	0.500	0.469	0.685	0.094	0.235	1.110	0.104	7,040	1,400	1.090